

## **Effect of forward facing supersonic jet on heat transfer rates over a blunt body in hypersonic flow**

K. P. J. Reddy\* and Vinayak Kulkarni  
High Enthalpy Aerodynamics Laboratory,  
Department of Aerospace Engineering,  
Indian Institute of Science, Bangalore-560 012, India.

### **Abstract**

Heat transfer reduction studies, in the presence of counterflow supersonic jet from the stagnation point of a 60-degree apex angle blunt cone, are conducted in a free piston driven hypersonic shock tunnel, HST3, to verify the effectiveness of this technique for high enthalpy flows. For flow Mach number of 8 with specific stagnation enthalpy of 5 MJ/kg, it has been observed that heat transfer rate, at a location close to the stagnation point on the model surface, decreases initially with increase in the injection pressure ratio (ratio of supersonic jet total pressure to the freestream pitot pressure) until the critical injection pressure ratio is reached. Forty five percent reduction in heat transfer rate, near stagnation point, has been measured for the critical injection pressure ratio of 14.9. Further increase in injection pressure ratio has reduced the overall percentage heat transfer reduction. Surface heat transfer reduction with counterflow supersonic jet from the stagnation point is found to be dependant on fluidic spike length where critical spike length gives the maximum reduction in heat transfer rate.

Keywords: *Hypersonic flow, drag reduction and free piston shock tunnel*

---

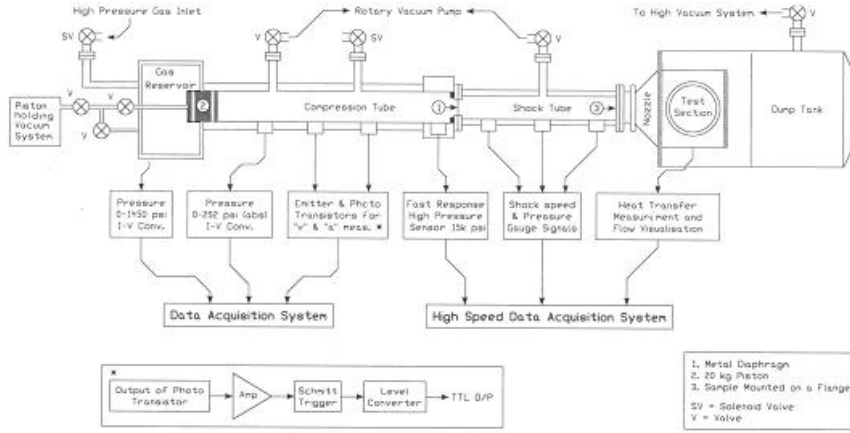
\*Author for correspondence. Email: [laser@aero.iisc.ernet.in](mailto:laser@aero.iisc.ernet.in), FAX: +91-80-23606223.

## **I. Introduction**

Highly blunted nose cone configuration is an essential feature of the hypersonic flight vehicle due to the associated aerodynamic heating phenomenon. Still the maximum temperature that a space vehicle experiences in its hypersonic flight is far above the maximum sustainable temperature of any conventional material. Forward facing supersonic jet as one of the techniques to alleviate this oncoming heat load has been studied in various aspects by various researchers. In an earlier investigation, McMahon [1] studied different ways of ejecting a cool gas from the nose of a blunt body and concluded that 'straight out' ejection, in the direction opposing the main air stream, is the most prominent way for effective heat transfer reduction. Warren [2] carried out experimental investigation of swirl and straight out injections of various coolants from the nose of the bluff body. During these investigations in the hypersonic wind tunnel, straight out injection of helium was observed as the most efficient technique for reduction of heat transfer rates. Niranjana Shao et. al. [3] studied the effect of supersonic jet opposing the oncoming hypersonic flow on the surface heat transfer rates during the explorations in the conventional shock tunnel. These low enthalpy hypersonic flow investigations have proved the usefulness of this technique for reduction of heat transfer rate. We investigated the effectiveness of this technique for high enthalpy flows recently in the recently established free piston driven shock tunnel at freestream Mach number 8.0 and stagnation enthalpy 5 MJ/kg using a 60 degree apex angle blunt cone model. The details of the test facility, test model and the measured heat transfer rates with and without supersonic gas injection are presented in this paper.

## **II. Experimental facility**

Experimental results reported here are carried out in the newly established free piston driven shock tunnel, HST3. The HST3 tunnel, shown schematically in Fig. 1, is of moderate size having a piston weight of 20 kg. The tunnel consists of a 10m long 165 mm internal diameter compression tube, 4.4 m long 39 mm diameter shock tube, a convergent-divergent Mach 8 conical nozzle and 2 m long 1 m diameter size test section cum dump tank. The piston is driven by nitrogen gas in 1m long 500 mm



(a)

(b)

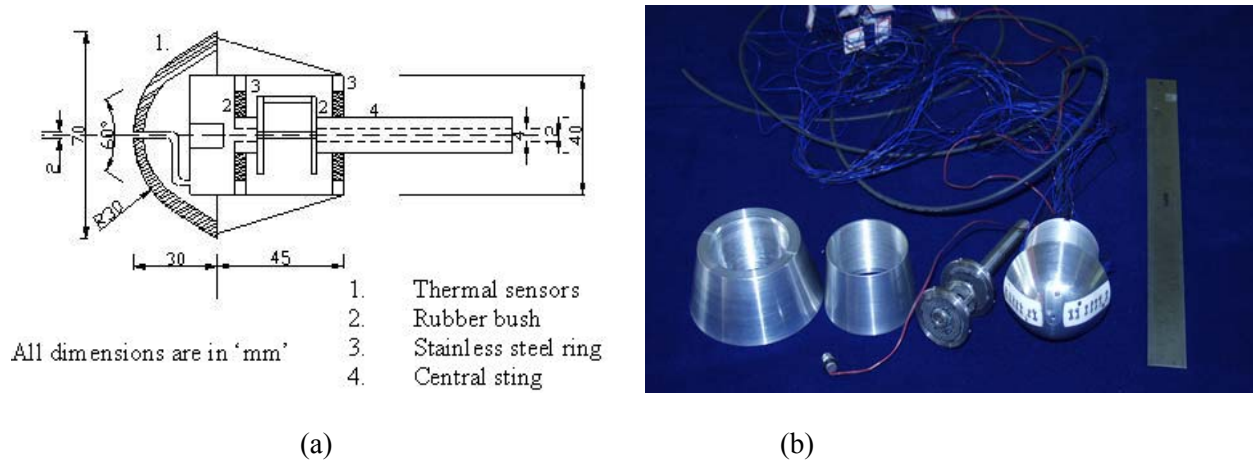
**Fig. 1.** Schematic diagram of the free piston driven hypersonic shock tunnel HST3 with pressure sensors mounted along the tube surface (a) and the photograph of the HST3 shock tunnel (b).

diameter secondary reservoir. The compression tube is provided with sensors at four locations to measure the acceleration and speed of the piston during the run. A pressure transducer is mounted at the end of the compression tube to monitor the compression tube pressure. The shock tube has two pressure sensors mounted known distance apart towards the end to monitor the shock speed and one pressure transducer at the end of the tube to measure the stagnation pressure at the entry of the nozzle. The tunnel has been calibrated for stagnation enthalpy of about 5MJ/kg. The flow quality and uniformity inside the test section is checked using the pitot rake on a traverse mechanism. The performance of the tunnel is estimated using different numerical codes based on the measured pitot signals and typical tunnel operating parameters are listed in Table 1.

**Table 1.** Typical free stream conditions of the free piston driven hypersonic shock tunnel, HST3.

Freestream static pressure ( $P_\infty$ )	0.284 kPa
Freestream static temperature ( $T_\infty$ )	316 K
Freestream Mach number ( $M_\infty$ )	~8.0
Freestream stagnation enthalpy ( $H_0$ )	~5.0 MJ/kg

In the present set of experiments for the calibrated freestream conditions, 60° apex angle blunt cone with 70 mm base diameter and bluntness ratio (defined by the ratio of nose diameter to base diameter) of 0.857, as shown in Fig. 2, is used. Platinum thin film sensors painted on the Macor substrate are used for heat transfer measurement with and without injection of supersonic jet from stagnation point. A solenoid based injection system is developed for injection of supersonic jet from the 2 mm orifice provided at the stagnation point of blunt cone model.



**Fig.2.** Schematic diagram of the 60 degree apex angle blunt cone fitted with an accelerometer based balance system and pipeline for injecting a supersonic jet from the stagnation point (a) and the photograph of the model with platinum thin film sensors along with the balance system (b)..

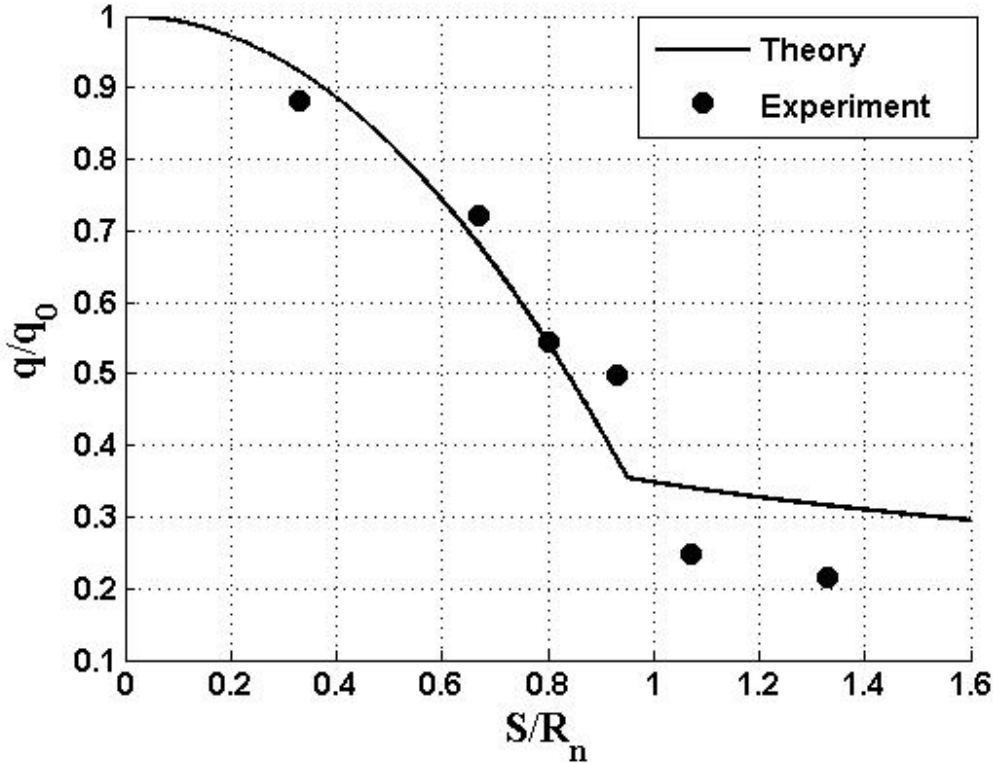
### III. Experimental studies

The 60-degree apex angle blunt cone model is mounted at zero degree angle of incidence in the test section of HST3. Experiments without and with injection of supersonic jet of different pressure ratios are conducted for the freestream conditions given in Table 1. Experiments without injection are carried out prior to the experiments with various injection pressure ratios. During the experiments with gas injection, solenoid based injector system is connected to a high pressure air cylinder equipped with a high pressure gas regulator to adjust and monitor the supply pressure of the gas to be injected. Synchronization of injection of supersonic jet from stagnation point with arrival of high enthalpy flow in the test section has been achieved by electronically triggering the injector using the signal output from the pressure sensor

mounted at the end of the compression tube. Different injection pressure ratios considered in the present heat transfer measurement studies are 7.45, 14.90, 22.36, 29.82 and 37.27.

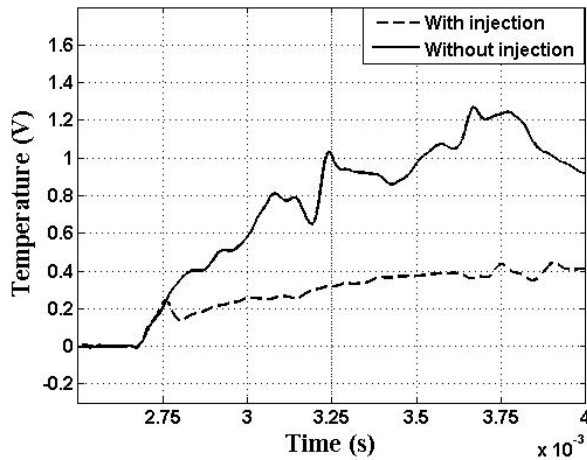
#### IV. Results and discussion

Experimentally obtained temperature signal at a particular location is used to get the heat transfer rate signal at that location using backing material and sensor material properties. Due to provision of orifice at the stagnation point for gas injection, heat transfer rate at that location is not measured, instead, it is calculated using expression given by Fay and Riddell [4]. Thus obtained stagnation point heat transfer rate is used to get the variation of nondimensional heat transfer rate over the model surface in the absence of supersonic jet. Comparison of theoretical [5] and experimental variation of nondimensional surface heat transfer rate, for no injection case, is shown in Fig 3.

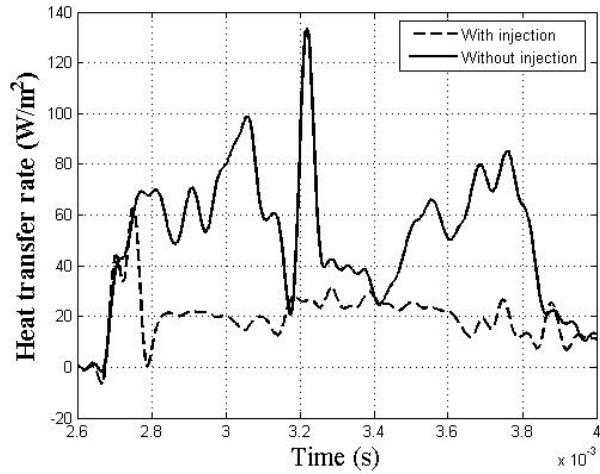


**Fig.3.** Comparison of theoretical and experimental variation of non-dimensional heat transfer rate along the model surface.

Temperature signals are obtained during the experiments with air injection for five different injection pressure ratios. Comparison of a typical temperature signal and the corresponding heat transfer signal, at the same location, with and without injection for a typical injection pressure ratio, is shown in Figs. 4 and 5, respectively.

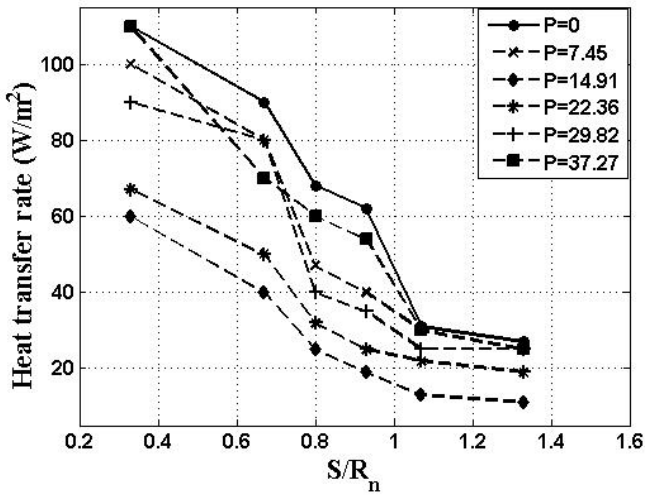


**Fig.4.** Typical temperature signals recorded with and without injection.

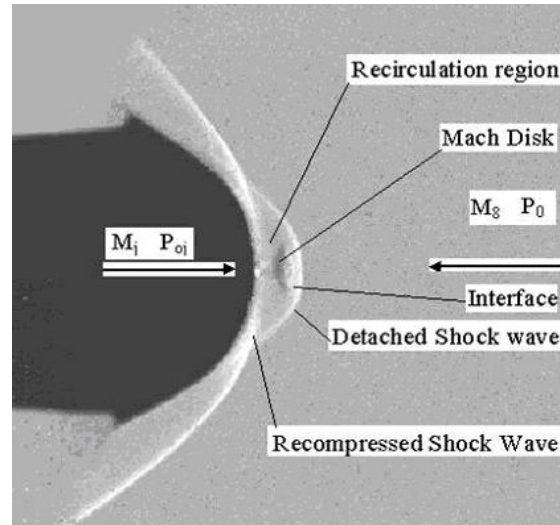


**Fig.5.** Typical heat transfer signals obtained from recorded signals with and without injection

Reduction in heat transfer rate is obvious from these signals. Variation of heat transfer rate on the model surface for different injection pressure ratios  $P$  is shown in Fig. 6. Heat transfer rate near stagnation point initially decreases with increase in injection pressure ratio. Maximum reduction in heat transfer rate of 45 % near the stagnation point has been observed for injection pressure ratio of 14.9. Further increase in injection pressure ratio decreases the percentage reduction of heat transfer near stagnation region and also overall heat transfer rates over the model. This behavior of the heat transfer rate variation along the model surface with injection pressure ratio can be understood from the changes in flowfield which take place due to gas injection with different injection pressure ratio. Typical flow field with counter flow supersonic jet of particular pressure ratio is shown in Fig 7.



**Fig.6.** Variation of heat transfer rates along the model surface for different injection pressure ratios.



**Fig.7.** Schlieren picture of flow features of hypersonic flow over the blunt cone with an opposing supersonic jet (Ref. 6).

In the process of interaction with oncoming hypersonic flow, jet emanating from the blunt body forms a fluidic spike mounted at stagnation point of the blunt cone model and pushes the bow shock wave away from body. After this interaction, fluid from the jet deflects out and flows back till it reattaches the blunt body where it forms a buffer layer between shocked high temperature flow and model surface. In this reversal flow path, fluid from the jet forms toroidal low pressure and low temperature recirculation region, presence of which in the vicinity of body reduces the surface heat flux. Length of the fluidic spike and region of jet reattachment depend on the injection pressure ratio for given freestream conditions. For optimum fluidic spike length, majority of the model surface gets covered by the recirculation region and hence more reduction in overall heat transfer can be expected. From this understanding, the reason for lower heat transfer reduction near stagnation region, at lowest injection pressure ratio (7.45), is the smaller length of fluidic spike which reattaches the jet flow very near to the stagnation point. Reduction in heat transfer for farther locations, for the same injection pressure ratio, is due to presence of buffer layer of jet. For the injection pressure ratio, 14.9, maximum reduction in heat transfer rate has been observed for all locations. Similar trend of surface heat transfer reduction has also been observed for injection

pressure ratio of 22.36. For these injection pressure ratios, the fluidic spike is expected to have optimum length to delay the reattachment of the jet towards the edge of the model. However, maximum reduction in heat transfer near stagnation region is measured as 45% for injection pressure ratio 14.90. Hence this injection pressure ratio is called as critical injection pressure ratio whereas the actual critical injection pressure ratio may be closer to these injection pressure ratios. With further increase in injection pressure ratio length of the fluidic spike increases more, which shifts the jet reattachment region towards stagnation point. Hence for higher injection pressure ratios, lesser reduction in heat transfer rate is observed near stagnation region.

#### **IV. Conclusions**

Reduction of heat transfer rates due to the counterflowing supersonic jet for a blunt body configuration in Mach 8 flow of 5 MJ/kg is investigated. Experiments for counter flow injection of supersonic jet are conducted for a 60-degree apex angle blunt cone model integrated with platinum thin film sensors for heat transfer measurement with and without injection. Experiments with supersonic jet injection are carried out for five injection pressure ratios by varying the total pressure of the jet. Maximum reduction of heat transfer rate of 45% near stagnation region is recorded for the critical injection pressure ratio of 14.9. Usefulness of this technique at higher enthalpy has been confirmed by these measurements.

#### **Acknowledgements**

We thank DST, DRDO, AR & DB and The Director, IISc for the financial support. Also, we thank the HEA Lab team for the technical help during the experimental work.

#### **References**

[1] McMahon HM. An experimental study of the effect of mass injection at the stagnation point of a blunt body. California Institute of Technology Guggenheim Aeronautical Laboratory, Hypersonic Research Project Memorandum No. 42, 1958.



[2] Warren CHE. An experimental investigation of the effect of ejecting a coolant gas at the nose of a bluff body. *J. Fluid Mechanics*. 1959, Vol. **8** (Part 3), pp. 400-417.

[3] Niranjana Sahoo, Vinayak Kulkarni, Saravanan S, Jagadeesh G and Reddy KPJ. Film cooling effectiveness on a large angle blunt cone flying at hypersonic speed. *Phys. Fluids*. 2005, Vol.17, Art. No.036102.

[4] Fay JA and Riddell FR. Theory of stagnation point heat transfer in dissociated air. *J. Aero. Sci.* 1958, Vol.25, pp. 73-85.

[5] Lee L. Laminar heat transfer rate over blunt nosed body at hypersonic speeds. *J propulsion*. 1956, Vol. 26, pp. 259-269.

[6] Balla Venukumar, Jagadeesh G and Reddy KPJ, Counterflow drag reduction by supersonic jet for a blunt body in hypersonic flow. *Phys. Fluids*. 2006, Vol.18, Art. No. 118104.